

产品图片	Features 产品特性	Application 应用
 <p>SOP4</p>	<ul style="list-style-type: none"> ● Contact Form 触点形式 1a ● Load Voltage 输出电压 60V ● Load Current 输出电流 500mA ● Operation LED Current 二极管导通电流 3.0mA ● On-Resistance 导通电阻 0.75Ω ● Output Capacitance 输出电容 45pF ● Low Off-State Leakage Current 漏电流 $1.0 \mu\text{A}$ 	<ul style="list-style-type: none"> ● Electric Vehicle 新能源电动汽车 ● Automatic Test Equipment 自动检测设备 ● Telephone Equipment 通信设备 ● Sensing Equipment 传感设备 ● Security Equipment 安全设备 ● I/O Modules I/O 模块 ● Modem 调制解调器

Dimensions 外形尺寸

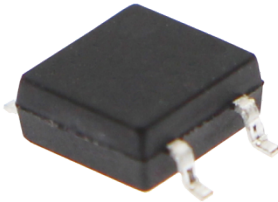

Terminal Identification 引脚标识

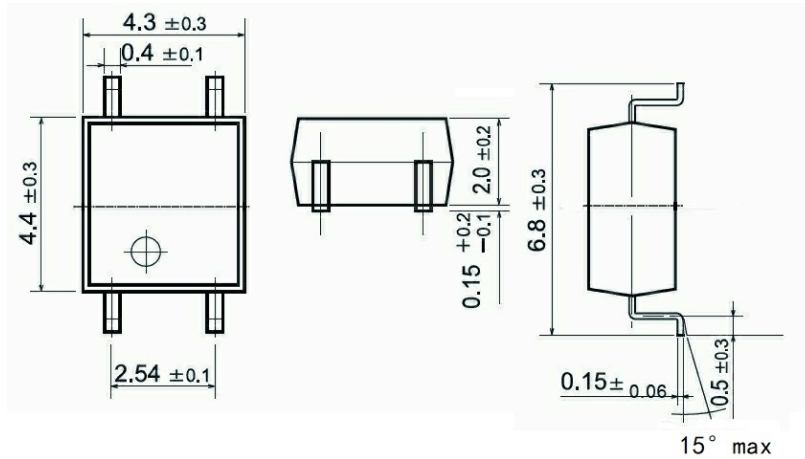
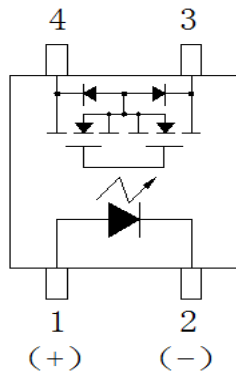

Wiring Diagram 接线图

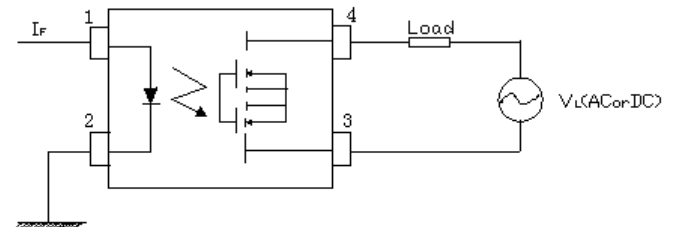

通讯地址: 陕西省西安市国家民用航天产业基地航天中路385号众创广场11层1101.1102.1104室

生产地址: 陕西省宝鸡市陈仓区群力路1号

邮政编码: 721300

电话: (0917)-6293969 18609177833

传真: (0917)-6293969



Technical parameters 技术参数 (Ambient Temperature 25°C)

I/O Absolute Maximum Ratings 输入输出电气参数最大值

Item 项目		Symbol 符号	Value 数值
Operating Temperature 工作温度		T_{OPR}	-40°C~+85°C
Storage Temperature 储存温度		T_{STG}	-40°C~+100°C
Input 输入	Continuous LED Current 工作电流	I_F	50mA
	Peak LED Current LED 峰值电流 (f=100Hz, Duty=1%)	I_{FP}	500mA
	LED Reverse Voltage 反向电压	V_R	5V
	Input Power Dissipation 输入功耗	P_{IN}	75mW
Output 输出	Load Voltage 输出电压	V_L	60V (AC peak or DC)
	Load Current 输出电流	I_L	500mA
	Peak Load Current 峰值输出电流 ((1ms, 1 shot)	I_{PEAK}	2000mA
	Output Power Dissipation 输出功耗	P_{OUT}	300mW
Total Power Dissipation 总功耗		P_T	350mW
I/O Breakdown Voltage 输入输出间隔离电压		$V_{I/O}$	1500Vrms
I/O Breakdown Voltage 输入输出间隔离电压 (加注 H)		$V_{I/O}$	3750Vrms

Electrical Specifications 输入输出电气参数

Item 项目		Symbol I 符号	MIN. 最小值	TYP. 典型值	MAX. 最大值	Units 单位	Conditions 条件
Input 输入	LED Forward Voltage 正向电压	V_F	1.0	1.17	1.5	V	$I_F=10mA$
	Operation LED Current 接通电流	$I_{F ON}$		0.9	3.0	mA	
	Recovery LED Voltage 关断电压	$V_{F OFF}$	0.5	1.0		V	
Output 输出	On-Resistance 导通电阻	R_{ON}		0.75	1.6	Ω	$I_F=5mA, I_L=Rating$ within 1sec.
	Off-State Leakage Current 漏电流	I_{LEAK}			1.0	μA	$V_L=60V$
	Output Capacitance 输出端容量	C_{OUT}		45		pF	$V_L=0V, f=1MHz$
Time parameters 时间参数	Turn-On Time 接通时间	T_{ON}		0.2	1.0	ms	$I_F=5mA, I_L=Rating$
	Turn-Off Time 关断时间	T_{OFF}		0.05	0.2	ms	
I/O 输入输出	I/O Insulation Resistance 绝缘电阻	$R_{I/O}$	10^9			Ω	
	I/O Capacitance 隔离电容	$C_{I/O}$		1.3		pF	$f=1MHz$

通讯地址: 陕西省西安市国家民用航天产业基地航天中路385号众创广场11层1101.1102.1104室

生产地址: 陕西省宝鸡市陈仓区群力路1号 邮政编码: 721300

电 话: (0917)-6293969 18609177833 传 真: (0917)-6293969



Reference Data 曲线图

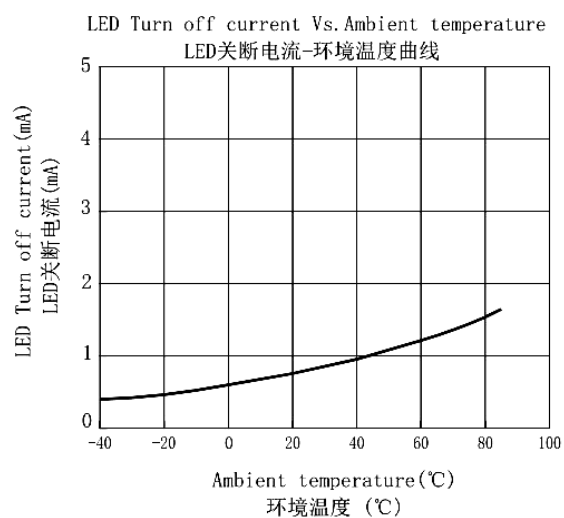
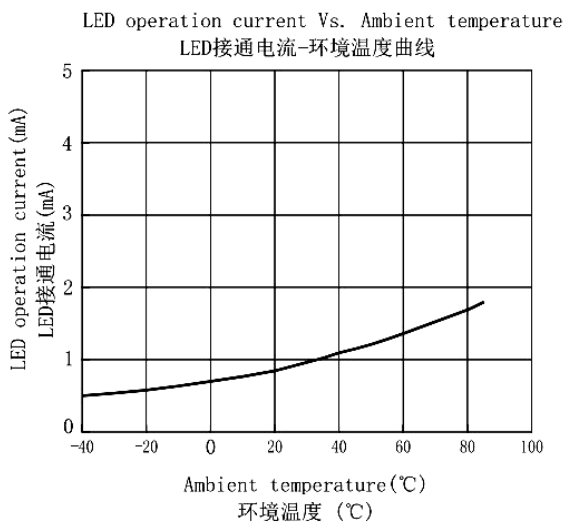
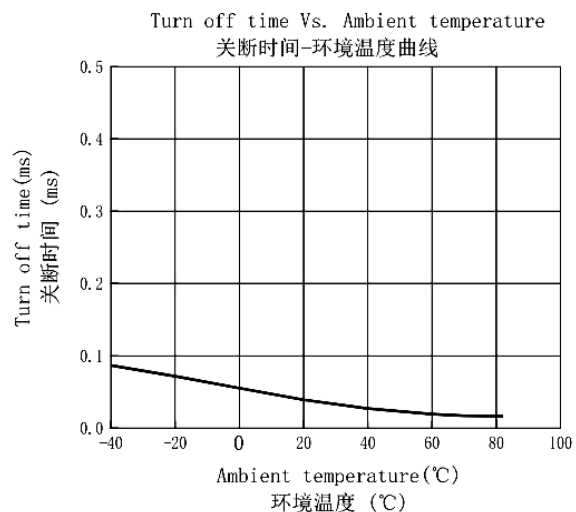
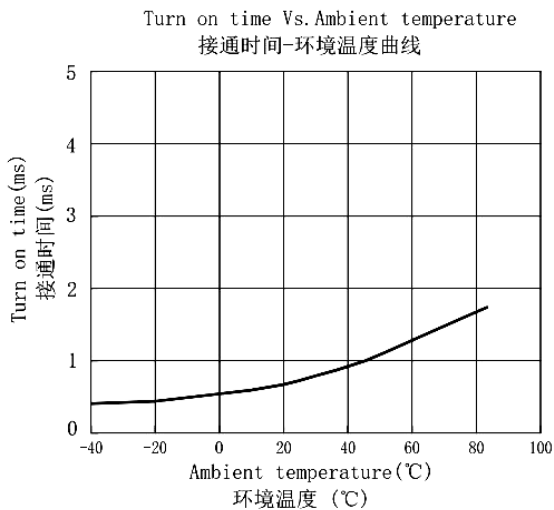
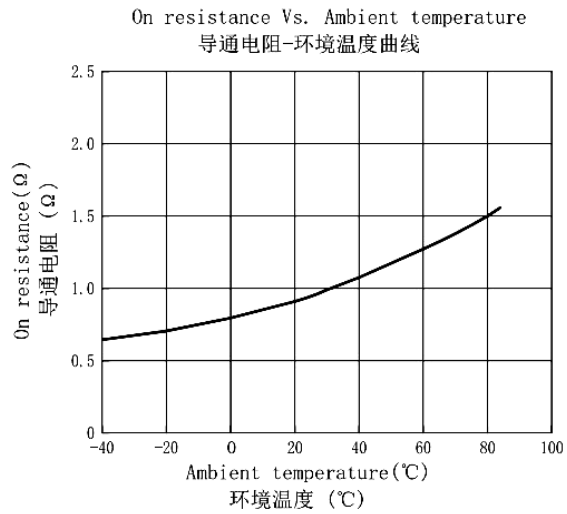
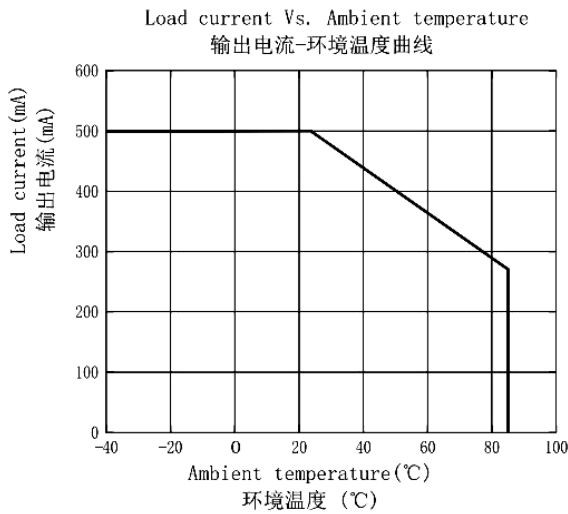

通讯地址: 陕西省西安市国家民用航天产业基地航天中路385号众创广场11层1101.1102.1104室

生产地址: 陕西省宝鸡市陈仓区群力路1号 邮政编码: 721300

电话: (0917)-6293969 18609177833

传真: (0917)-6293969



BCY212S 型光 MOS 继电器

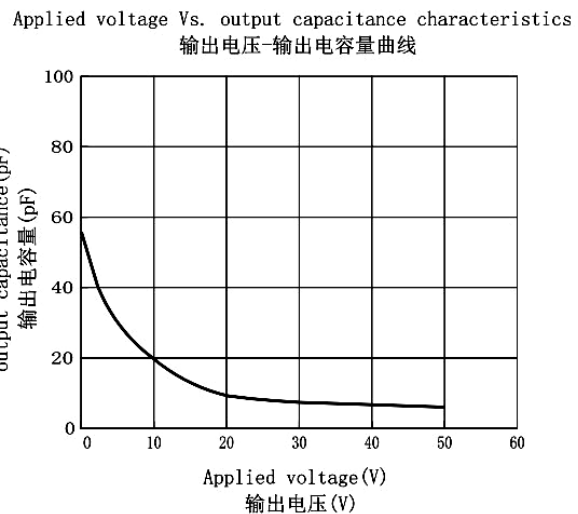
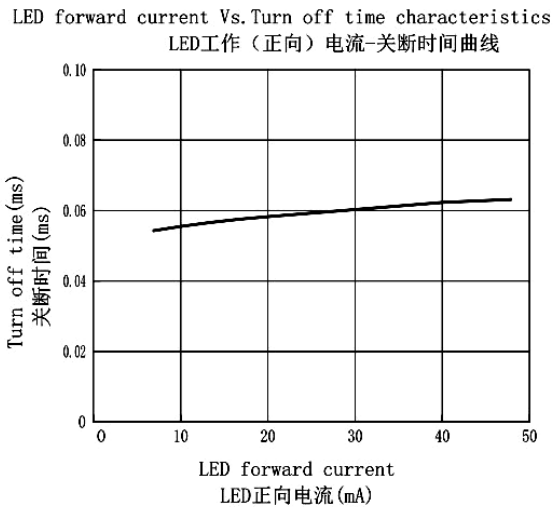
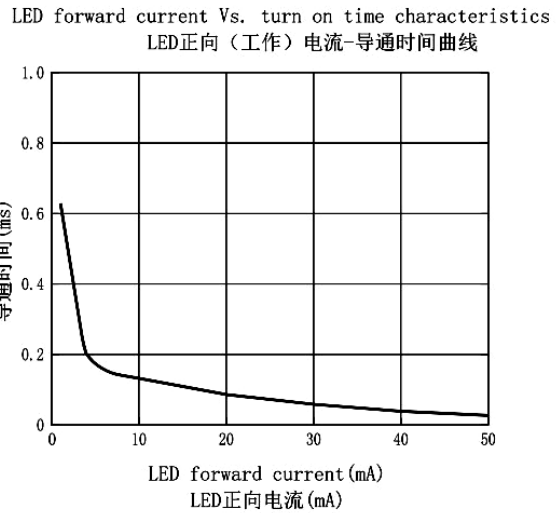
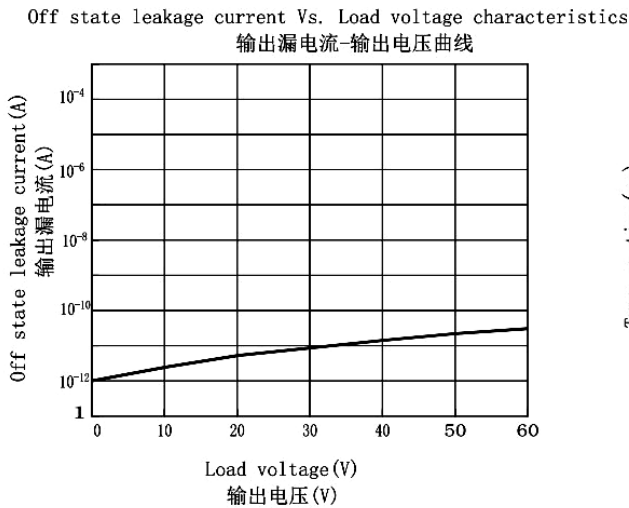
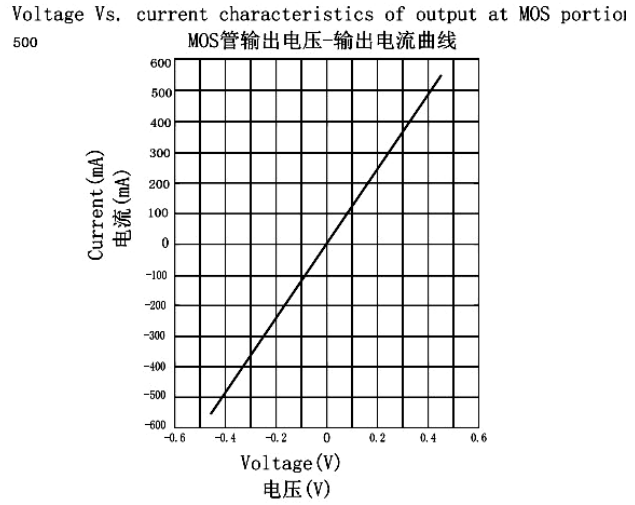
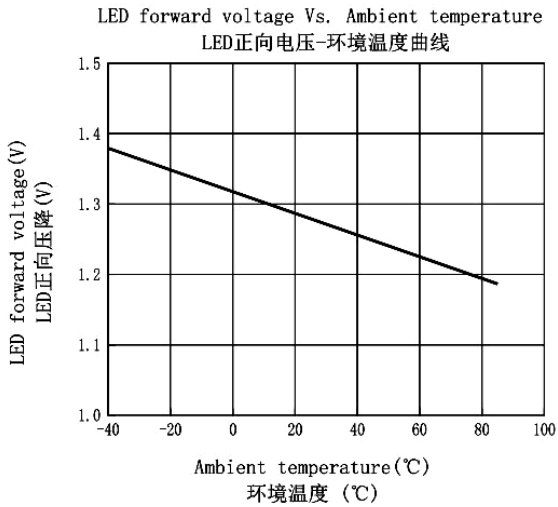

通讯地址: 陕西省西安市国家民用航天产业基地航天中路385号众创广场11层1101.1102.1104室

生产地址: 陕西省宝鸡市陈仓区群力路1号 邮政编码: 721300

电话: (0917)-6293969 18609177833 传真: (0917)-6293969